

Data Sheet



Article number: 201282100AL

Description: E+G Hinge for weld mounting GN 128.2-100-AL
Aluminium hinge/pin stainless 1.4301

Measures

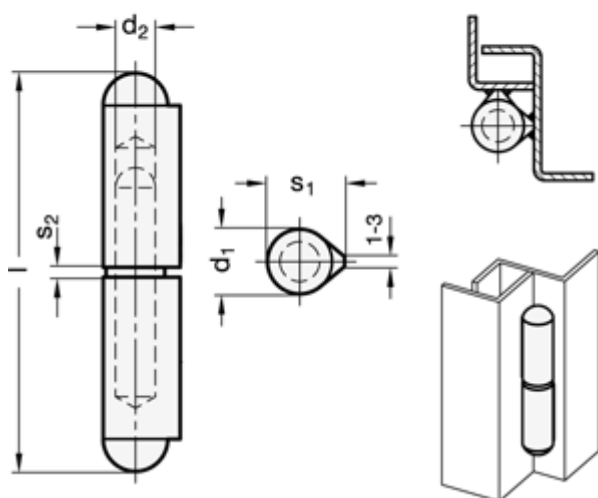

d1	= 16
d2	= 10
Length l	= 100
s1	= 20.0
s2	= 3